

SPECIFICATIONS

MATERIAL/COLOR	FLUOROELASTOMER COATED FIBERGLASS/BLACK
TEMPERATURE RATING	-70°C to +220°C (-94°F to +428°F)
TENSILE STRENGTH	2000 psi @ 24°C; 600 psi @ 149°C
ELONGATION	150% @ 24°C; 75% @ 149°C
RATINGS	ASTM-D350, UL 1441, NEMA TF-1, MIL-E-5272, MIL-I-3190/7

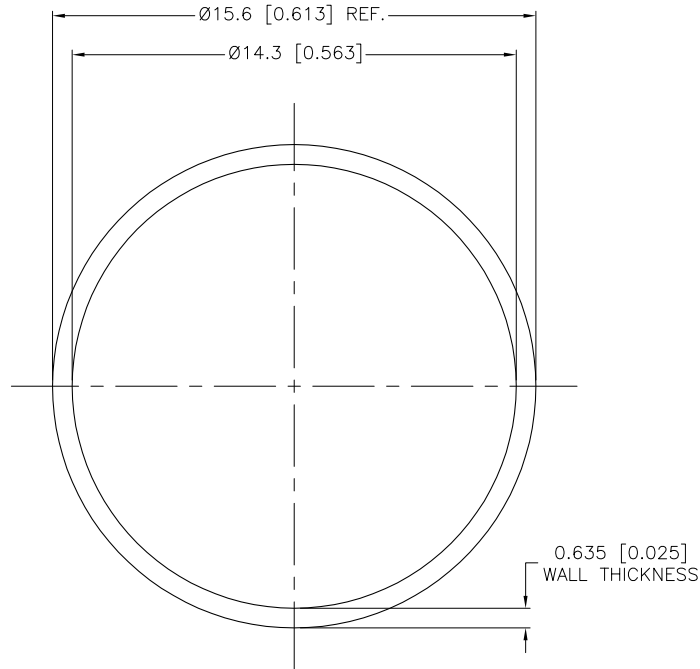

SOURCE DRAWING - FOR REFERENCE ONLY

NOTES:

1. 50 FOOT SPOOL OF VITON SLEEVING.

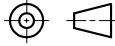
RELATED DOCUMENTS		3RD ANGLE PROJECTION		THIS DRAWING IS PROPERTY OF TURCK INC. USE OF THIS DOCUMENT WITHOUT WRITTEN PERMISSION IS PROHIBITED.		 3000 CAMPUS DRIVE MINNEAPOLIS, MN 55441 1-800-544-7769 (763) 553-7300 (763) 553-0708 fax turck.com	
1. 2. 3. 4.				DRFT	RDS	DATE	07/28/08
MATERIAL		ALL DIMENSIONS DISPLAYED ON THIS DRAWING ARE FOR REFERENCE ONLY		DSGN		SCALE	1=.3
SEE SPECIFICATIONS		CONTACT TURCK FOR MORE INFORMATION		UNIT OF MEASUREMENT		DESCRIPTION	
FINISH				MILLIMETER [ INCH ]		FFV 5/8INCH BLACK 50 FOOT ROLL	
SEE SPECIFICATIONS				DO NOT SCALE THIS DRAWING		IDENTIFICATION NO.	REV
						A9202	A
A	DRAWING RELEASE	RDS	07/29/08			FILE: A9202	SHEET 1 OF 1
REV	DESCRIPTION	BY	DATE	ECO NO.			